



INSTRUCTIONS D'ASSEMBLAGE
ASSEMBLY INSTRUCTIONS

MONARCH
SPECIALTIES INC.

I 3001

TABLE D'APPOINT -
CAPPUCCINO AVEC VERRE TREMPE

ACCENT TABLE -
CAPPUCCINO BENTWOOD WITH TEMPERED GLASS





**POUR DE L'ASSISTANCE OU POUR COMMANDER
DES PIÈCES CONTACTEZ NOTRE DÉPARTEMENT
DE SERVICE À LA CLIENTÈLE.**

**FOR ASSISTANCE OR TO ORDER PARTS
CONTACT OUR CUSTOMER SERVICE DEPARTMENT**

WWW.MONARCHSERVICE.COM

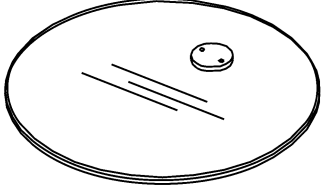
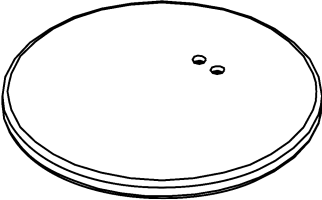
LISTE DES PIÈCES
PARTS LIST

PIÈCE / PART #	IMAGE	DESCRIPTION	QTY / QTÉ
1		<p align="center">GLASS TOP SURFACE EN VERRE</p>	1
2		<p align="center">BOTTOM PANEL PANNEAU DU BAS</p>	1
3		<p align="center">SUPPORT BAR BARRE DE SOUTIEN</p>	1

LISTE DES PIÈCES DE MONTAGE
HARDWARE LIST

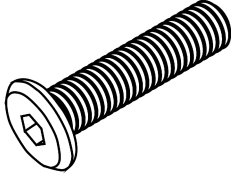
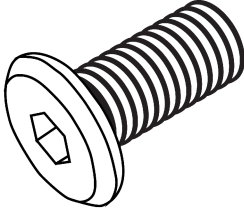
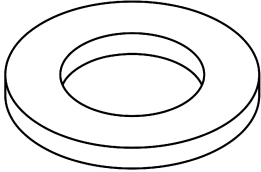
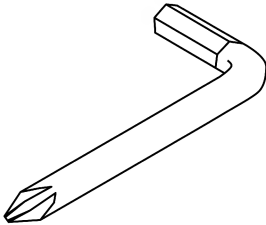
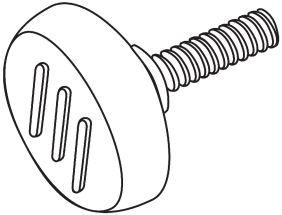
PIÈCE / PART #	IMAGE	DESCRIPTION	QTY / QTÉ
A		ASSEMBLING BOLT - Ø1/4" X 2" BOULON D'ASSEMBLAGE - Ø1/4" X 2"	2
B		ASSEMBLING BOLT - Ø1/4" X 3/8" BOULON D'ASSEMBLAGE - Ø1/4" X 3/8"	2
C		METAL WASHER - Ø1/4" X 5/8" RONDELLE DE MÉTAL - Ø1/4" X 5/8"	2
D		HEX KEY CLÉ HEXAGONALE	1
E		ADJUSTABLE LEG - Ø1/4" X 1/2" PATTE AJUSTABLE - Ø1/4" X 1/2"	4

LISTE DES PIÈCES DE MONTAGE
HARDWARE LIST

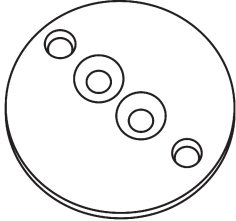
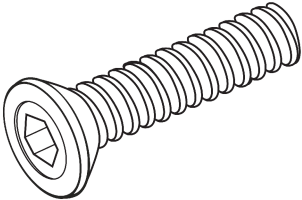
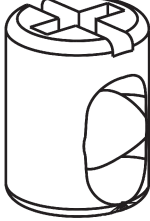
PIÈCE / PART #	IMAGE	DESCRIPTION	QTY / QTÉ
F		<p align="center">SUPPORT PLATE - Ø2 3/8"</p> <p align="center">PLAQUE DE SUPPORT - Ø2 3/8"</p>	1
G		<p align="center">ASSEMBLING BOLT - Ø1/4" X 1 3/8"</p> <p align="center">BOULON D'ASSEMBLAGE - Ø1/4" X 1 3/8"</p>	2
H		<p align="center">BARREL NUT - Ø1/4" X 1/2"</p> <p align="center">ÉCROU DE CANON - Ø1/4" X 1/2"</p>	4

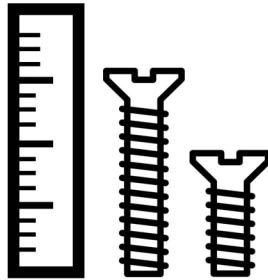

OUTIL DE VÉRIFICATION DE DIMENSIONS DES PIÈCES
HARDWARE DIMENSIONS VERIFICATION TOOL

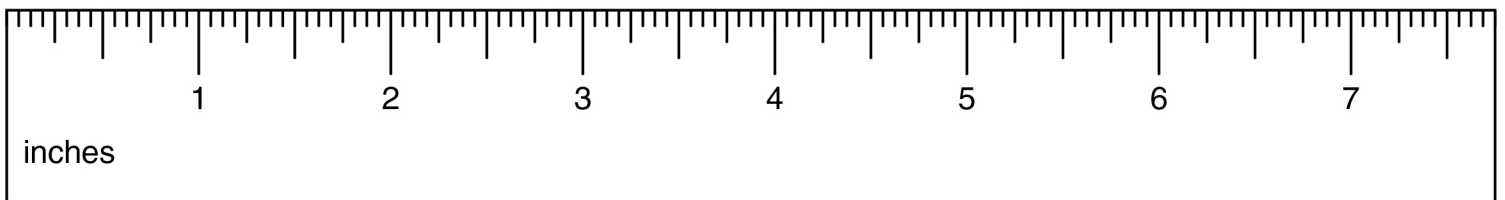

ÉTAPE / STEP 1

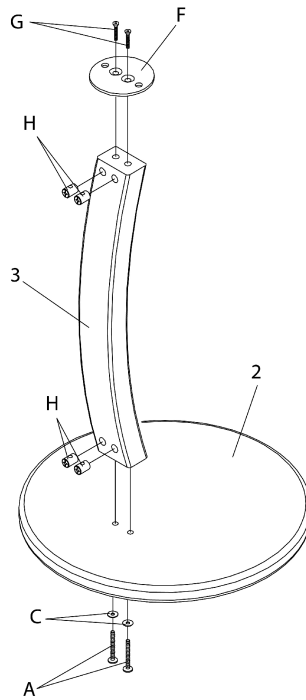

ÉTAPE / STEP 2

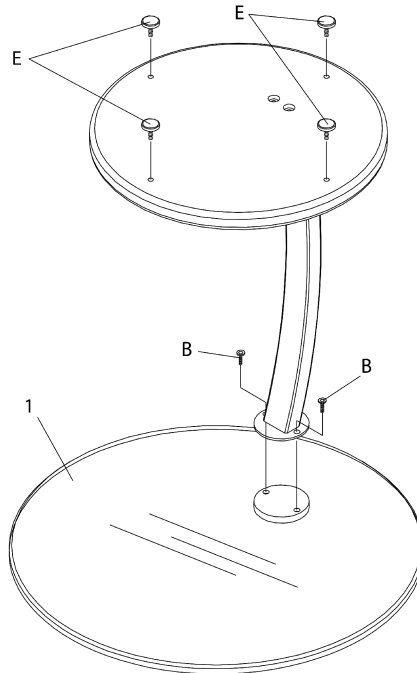

ÉTAPE / STEP 3

